

KOMATSU®

PC800-8E0 BACKHOE PC800-8E0 LOADING SHOVEL

ecot3

PC
800

HORSEPOWER

Gross: 370 kW 496 HP @ 1800 rpm

Net: 363 kW 487 HP @ 1800 rpm

OPERATING WEIGHT

Backhoe: 74500–78110 kg

164,240–172,200 lb

Loading shovel: 77300 kg

170,420 lb



Photo may include optional equipment.

HYDRAULIC EXCAVATOR

WALK-AROUND

Productivity Features

- **High Work Equipment Speed**
Arm quick return circuit enables loading work to be quicker than ever, by reducing hydraulic pressure loss of arm dumping.
- **Heavy Lift Mode**
The heavy lift mode increases lifting force by 10%.
- **Large Digging Force**
Pressing the Power Max function button temporarily increases the digging force.
- **Two-mode Setting for Boom**
Switch selection allows either powerful digging or smooth boom operation.
- **Large Drawbar Pull and Steering Force**
provide excellent mobility.
- **Swing Priority Mode**
The swing priority mode improves efficiency for loading dump trucks at 90° or 180°.
- **Shockless Boom Control**
Switch selection reduces chassis vibration after sudden stops.

See page 5.

Reliability and Durability Features

- **KMAX Bucket Teeth** offer superior penetration and long-term sharpness.
- **Fuel Pre-filter** with water separator and **High Efficiency Fuel Filter** equipped as standard.
- **O-ring Face Seals**, which have excellent sealing performance, are used for the hydraulic hoses.
- **High-pressure In-line Filtration**
The cool-running hydraulic system is protected with the most extensive filtration system available, including a high pressure in-line filter for each main pump.



Maintenance Features

- **Easy Cleaning of Cooling Unit**
Fan reverse-rotation function facilitates clogged radiator cleaning.
- **Easy Checking and Maintenance of Engine**
- **Large Handrail, Step and Catwalk** provide easy access to the engine and hydraulic equipment.

See page 11.

Ecology and Economy Features

- **Low Emission Engine**
A powerful, turbocharged and air-to-air aftercooled Komatsu SAA6D140E-5 provides **363 kW 487 HP**. This engine is U.S. EPA Tier 3 and EU Stage 3A emissions certified, without sacrificing power or machine productivity.
- **Economy Mode Four-level Setting**
Enables operator to select the appropriate Economy mode level to match production requirement with lowest fuel consumption.
- **Reduction of Ambient Noise**
 - Electronically controlled variable speed fan drive
 - Large hybrid fan
 - Low-noise muffler
- **Mode Selection**
 - Economy mode improves fuel consumption.
 - ECO gauge for energy-saving operations
 - Extended idling caution for fuel conservation
 - Auto deceleration and auto idling system reduce fuel consumption.

See pages 4, 5.



Photo may include optional equipment.

Working Environment

- **Large Comfortable Cab**
 - Low-noise cab
 - Low vibration with cab damper mounting
 - Highly pressurized cab with optional air conditioner
 - Operator seat and console with armrest that enables operations in the appropriate operational posture.
 - OPG top guard level 2 (ISO 10262) capable with optional bolt-on top guard

See pages 8, 9.

Large Liquid Crystal Display (LCD) Monitor

- Easy-to-see and use 7" large multi-function color monitor
- Can be displayed in 12 languages for global support.

See page 10.

HORSEPOWER
Gross: 370 kW 496 HP @ 1800 rpm
Net: 363 kW 487 HP @ 1800 rpm

OPERATING WEIGHT
Backhoe
74500–78110 kg
164,240–172,200 lb
Loading shovel
77300 kg
170,420 lb

PRODUCTIVITY & ECOLOGY FEATURES

Komatsu Technology



Komatsu develops and produces all major components, such as engines, electronics and hydraulic components, in house. With this "Komatsu Technology," and adding customer feedback, Komatsu is achieving great advancements in technology. To achieve both high levels of productivity and economical performance, Komatsu has developed the main components with a total control system.

The result is a new generation of high performance and environment friendly excavators.

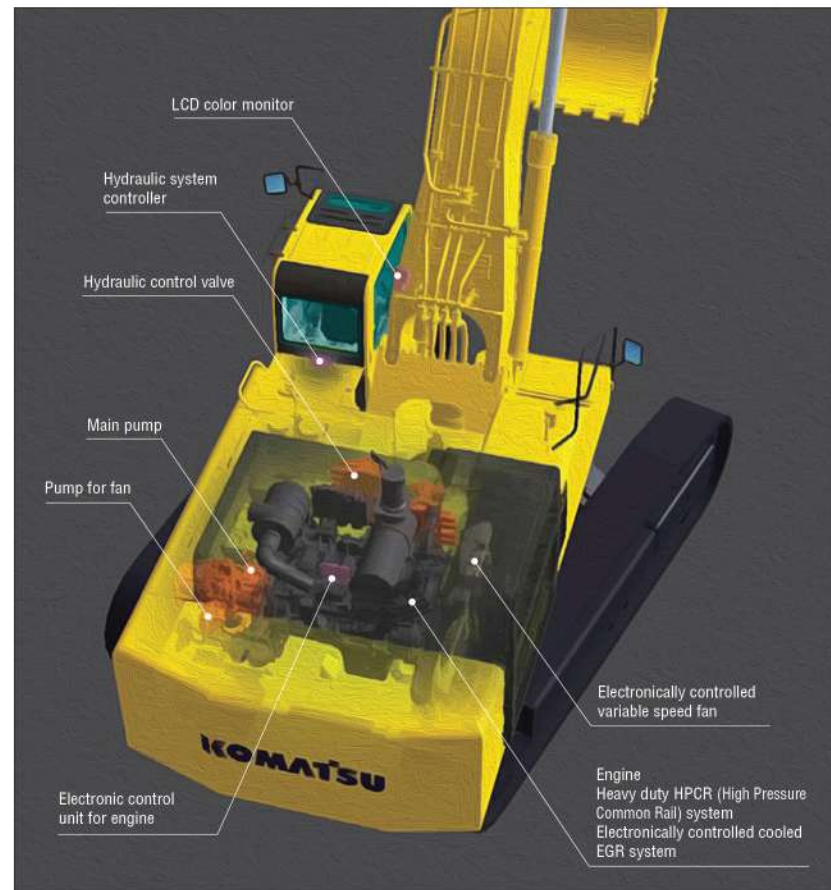

Low Emission Engine

Komatsu SAA6D140E-5 engine is U.S. EPA Tier 3 and EU Stage 3A emissions certified, without sacrificing power or machine productivity.



Electronically Controlled Variable Speed Fan Contributes to Low Fuel Consumption and Low Noise

The electronic control system sets the revolution speed of the cooling fan according to the coolant, hydraulic oil, and ambient temperature; effectively uses the engine output to prevent wasteful fuel consumption; and reduces noise during low-speed fan revolution.

Lower and Economical Fuel Consumption Using Economy Mode

Enables operator to set the Economy mode to four levels according to working conditions so that production requirement is achieved at lowest fuel consumption.



Reduction of Ambient Noise

Reduced noise by adoption of an electronically controlled variable speed fan drive, large hybrid fan and low-noise muffler.

ECO Gauge that Assists Energy-saving Operations

ECO gauge is equipped for environment friendly energy-saving operations. Focus on operation in the green range allows reduction of CO₂ emission and fuel consumption.



ECO gauge

Idling Caution

To prevent unnecessary fuel consumption, an idling caution is displayed on the monitor, if the engine idles for 5 minutes or more.



Auto Deceleration and Auto Idling System

Auto deceleration system is equipped to reduce fuel consumption and operating noise. Also, engine idling speed can be set at a lower speed on monitor with auto idling system.

Working Modes Selectable

P and E modes established work modes are further improved.

P mode – Power or work priority mode has low fuel consumption, but fast equipment speed and maximum production and power are maintained.

E mode – Economy or fuel saving mode further reduces fuel consumption, but maintains the P-mode-like working equipment speed for light duty work.

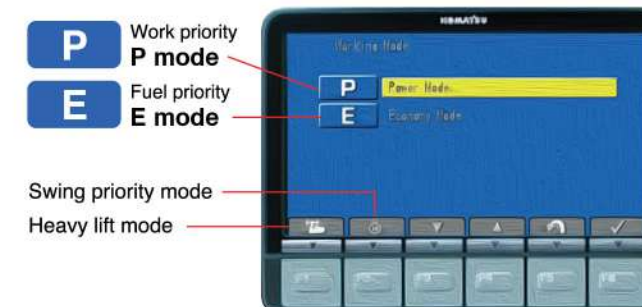

Swing priority mode
Heavy lift mode

You can select Power or Economy modes using a one-touch operation on the monitor panel depending on workloads.

Heavy Lift Mode

Gives 10% more lifting force when needed for handling rock or heavy lifting applications.

Swing Priority Mode

The swing priority mode allows the operator to use the same easy motion for 180° loading as 90° loading operations. By altering the oil flow, this setting allows you to select either boom or swing as the priority for increased production.

Selection	Result
ON	Oil flow to the swing motor is increased. 180° loading operations are most efficient.
OFF	Oil flow to the boom is increased. 90° loading operations are most efficient.

Large Digging Force

With the one-touch Power Max. function digging force is further increased. (approx. 8.5 seconds of operation)

Maximum arm crowd force (ISO 6015):
250 kN (25.5 tonf) → **273 kN (27.9 tonf)** **9.4% UP**
(with Power Max.)

Maximum bucket digging force (ISO 6015):
333 kN (34.0 tonf) → **364 kN (37.2 tonf)** **9.4% UP**
(with Power Max.)

*Measured with Power Max function, 3600 mm 11'10" arm and ISO 6015 rating

Work Equipment Speed

An arm quick return circuit is provided for arm dumping. This returns a portion of oil flow directly to the hydraulic tank at arm dumping to reduce the hydraulic pressure loss. Speedier loading work can be accomplished by work equipment with quicker movement.

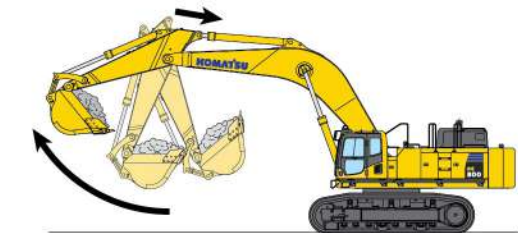

Large Drawbar Pull and Steering Force

Since the machine has a large drawbar pull and a high steering force, it demonstrates excellent mobility even when it is on inclined sites.

Two-mode Setting for Boom

Smooth mode provides easy operation for gathering blasted rock and scraping operations. When maximum digging force is needed, switch to **power mode** for more effective excavating.

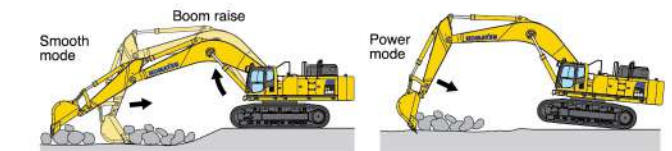

Shockless Boom Control

The PC800-8E0 boom circuit features a shockless valve (double-check slow return valve) to automatically reduces the amount of vibration present when operating the boom. Operator fatigue is reduced (which can improve safety and productivity), and spillage caused by vibration is minimized.

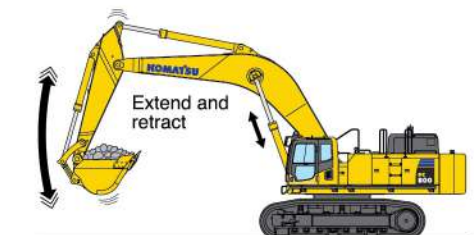

RELIABILITY & DURABILITY FEATURES

Boom Foot Hoses

The boom foot hoses are arranged under the boom foot to reduce hose bend during operation, extending hose life and improving operator safety.



Metal Guard Rings

Metal guard rings protect all the hydraulic cylinders and improve reliability.

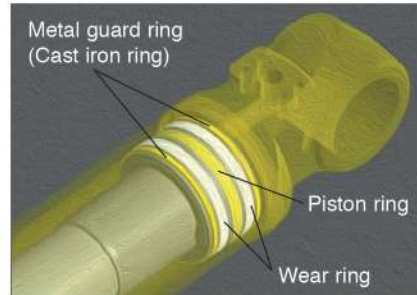

Sturdy Undercarriage

The undercarriage is strengthened to provide excellent reliability and durability when working on rocky ground or blasted rock.

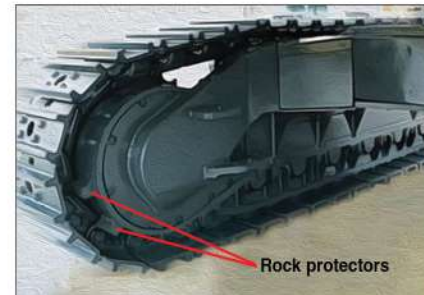

Sturdy guards shield the travel motors and piping against damage from rocks.

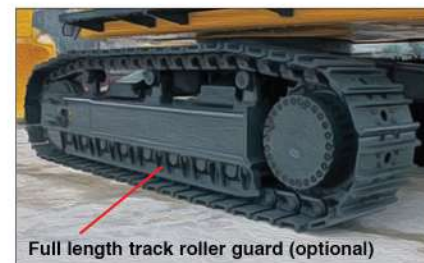

O-ring Face Seal

The hydraulic hose seal method has been changed from a conventional taper seal to an O-ring seal. This provides improved sealing performance during operation.

Heat-resistant Wiring

Heat-resistant wiring is utilized for the engine electric circuit and other major component circuit.



Fuel Pre-filter (with Water Separator)

Removes water and contaminants from fuel to enhance the fuel system reliability.



Circuit Breaker

With circuit breaker, the machine can be easily restarted after repair.

High Efficiency Fuel Filter

Fuel system reliability is even better with high efficiency fuel filter.

High-pressure In-line Filtration

The PC800-8E0 has the most extensive filtration system available, providing in-line filters as standard equipment. An in-line filter in the outlet port of each main hydraulic pump reduces failures caused by contamination.

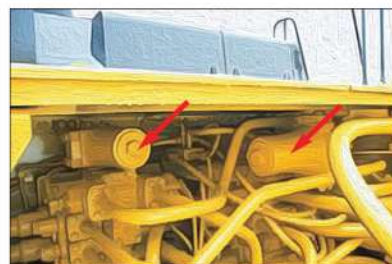

Photo is PC850-8E0. Photo may include optional equipment.

Strengthened Quarry Bucket Provides Outstanding Wear-resistance (optional for SE spec.)

The PC800-8E0 has the bucket for specific use in quarry, this is strong in impact and wear, and providing high performance and long life. Komatsu K VX's hard materials* provide excellent wear resistance. Combined with adoption of long-life KMAX teeth, durability of bucket is drastically enhanced.

* Komatsu K VX's hard materials: Komatsu K VX developed, wear-resistant, reinforced materials. Brinell hardness: 500 or more (180kgf/mm² class). Features high wear-resistance and little quality change from the heat generated during rock loading, maintaining long term hardness.

KMAX Tooth

- Unique bucket tooth shape, superior digging performance
- Long-term high sharpness
- Great penetration performance
- Hammerless, safe, and easy tooth replacement (Tooth replacement time: Halves the conventional machine.)

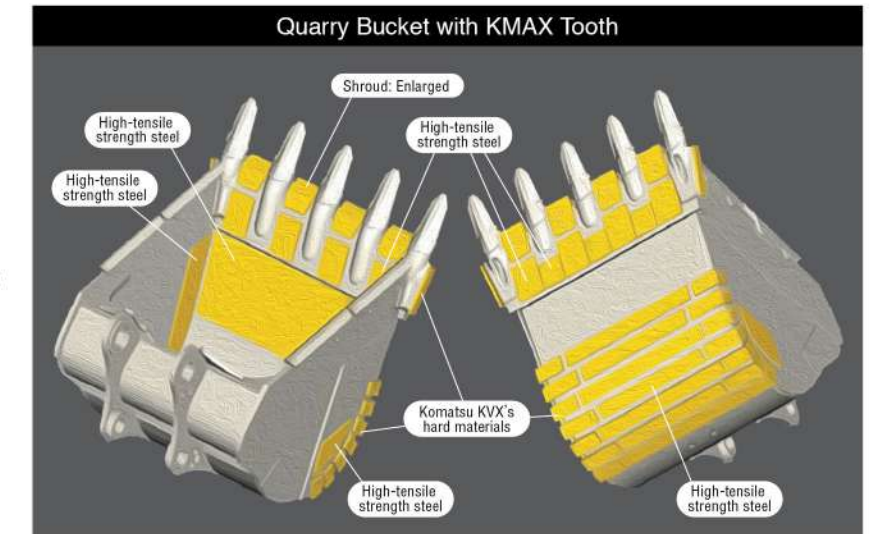

STEP 1

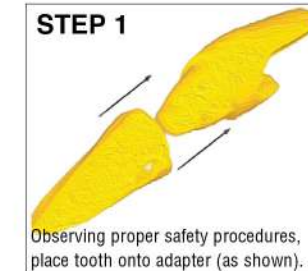

Observing proper safety procedures, place tooth onto adapter (as shown).

STEP 2

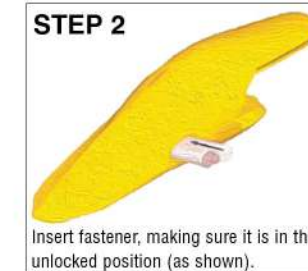

Insert fastener, making sure it is in the unlocked position (as shown).

STEP 3

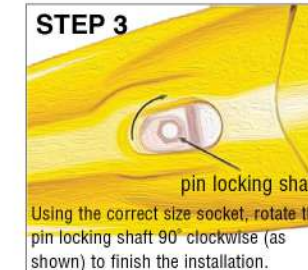

Using the correct size socket, rotate the pin locking shaft 90° clockwise (as shown) to finish the installation.

STEP 4

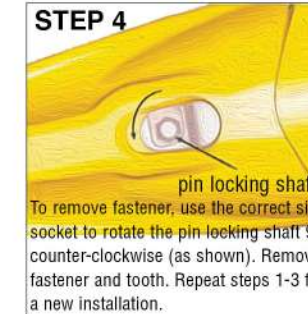

To remove fastener, use the correct size socket to rotate the pin locking shaft 90° counter-clockwise (as shown). Remove fastener and tooth. Repeat steps 1-3 for a new installation.

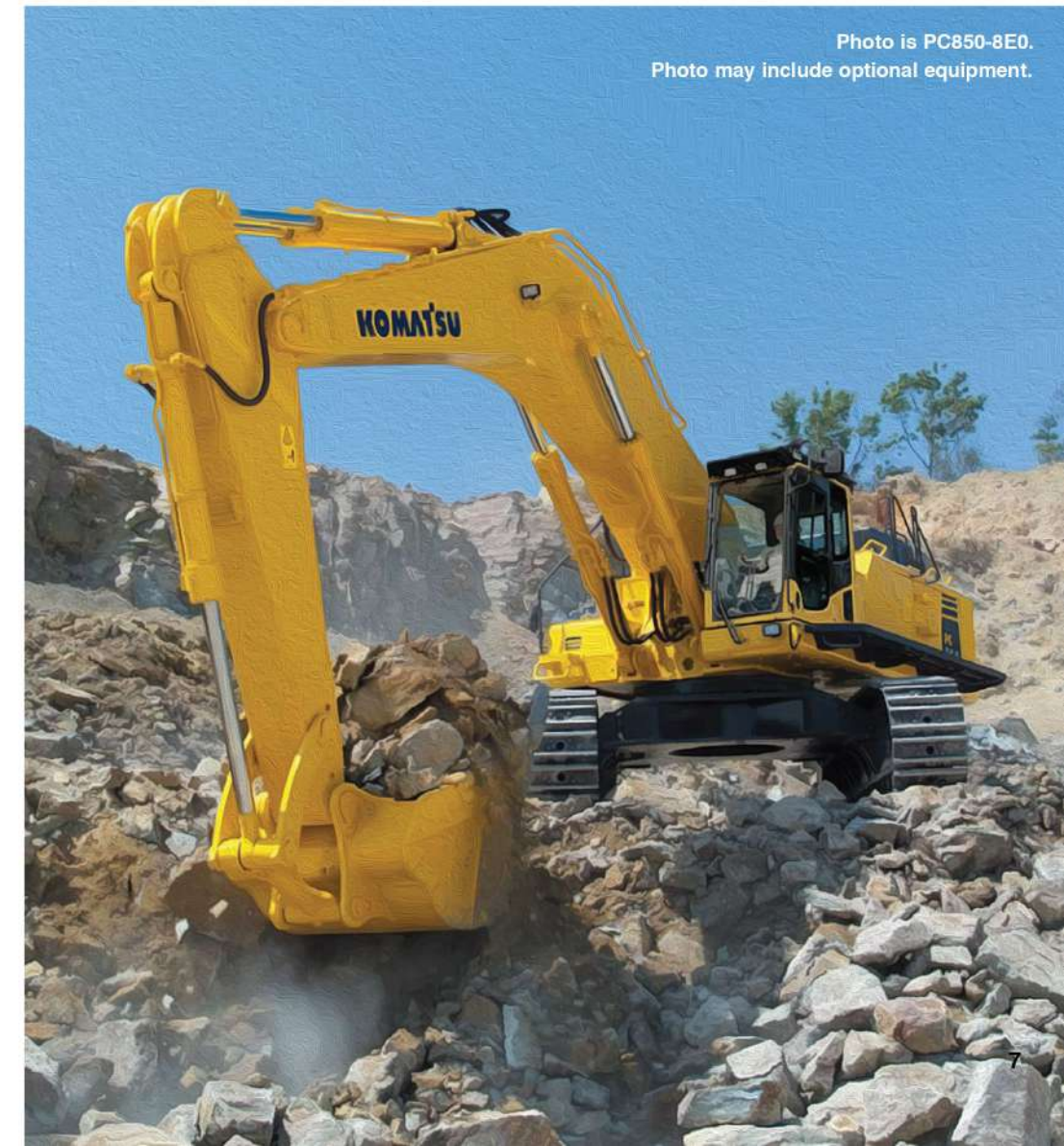

Photo is PC850-8E0. Photo may include optional equipment.

WORKING ENVIRONMENT



Photo may include optional equipment.

Low Noise Design Cab

The newly-designed cab is highly rigid and has excellent sound absorption ability. Thorough improvement of noise source reduction and use of low noise engine, hydraulic equipment, and air conditioner allows the operator to work in quiet condition.

Operator ear's noise **2 dB(A) reduced**

Compared with the current model

Wide Newly-designed Cab

Newly-designed wide spacious cab includes seat with reclining backrest. The seat height and longitudinal inclination are easily adjusted using a pull-up lever. You can set the appropriate operational posture of armrest together with the console. Reclining the seat further enables you to place it into the fully flat state with the headrest attached.



Seat with headrest reclined full flat

Pressurized Cab

Optional air conditioner, air filter and a higher internal air pressure (+6.0 mm Aq +0.2"Aq) prevent external dust from entering the cab.

Multi-position Controls

The multi-position, Pressure Proportional Control (PPC) levers allow the operator to work in comfort while maintaining precise control. A double-slide mechanism allows the seat and control levers to move together or independently, allowing the operator to position the controls for maximum productivity and comfort.



Seat sliding amount: 340 mm 13.4"

Low Vibration with Cab Damper Mounting

PC800-8E0 uses viscous damper mounting for cab that incorporates longer stroke and the addition of a spring. The cab damper mounting combined with high rigidity deck aids vibration reduction at operator seat.

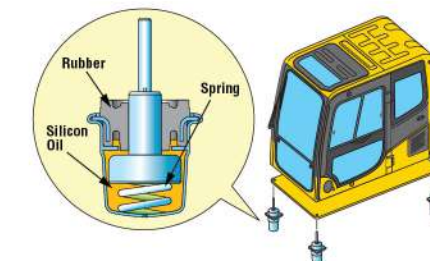

Cab Equipments



Skylight



Sliding Window and Large Side Mirror



Defroster (optional)



Cab Frame Mounted Wiper



Bottle Holder and Magazine Rack

Automatic Air Conditioner (optional)

Enables you to easily and precisely set cab atmosphere with the instruments on the large LCD. The bi-level control function keeps the operator's head and feet cool and warm respectively. This improved air flow function keeps the inside of the cab comfortable throughout the year. Defroster function keeps front glass clear.

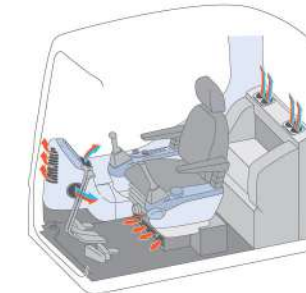

Safety Features

Step Light with Timer

provides light for about one minute to allow the operator to get off the machine safely.



Pump/engine Room Partition

prevents oil from spraying on the engine if a hydraulic hose should burst.



Thermal and Fan Guards

are placed around high-temperature parts of the engine and fan drive.

Slip-resistant Plates

Spiked plates on working areas provide slip-resistant performance.

Horn Interconnected with Warning Light (optional)

gives visual and audible notice of the excavator's operation when activated.



Rear View Monitoring System (optional)

The operator can view the rear of the machine with a color monitor screen.



Large LCD Color Monitor

Large Multi-lingual LCD Monitor

A large user-friendly color monitor enables safe, accurate and smooth work. Improved screen visibility is achieved by the use of LCD that can easily be read at various angles and lighting conditions. Simple and easy to operate switches. Function keys facilitate multi-function operations. Displays data in 12 languages to support operators around the world.



- Indicators**
- 1 Auto-decelerator
 - 2 Working mode
 - 3 Travel speed
 - 4 Engine water temperature gauge
 - 5 Hydraulic oil temperature gauge
 - 6 Fuel gauge
 - 7 ECO gauge
 - 8 Function switches menu

- Basic operation switches**
- 1 Auto-decelerator (& auto idling)
 - 2 Working mode selector
 - 3 Traveling selector
 - 4 Buzzer cancel
 - 5 Wiper
 - 6 Windshield washer

Mode Selection

The multi-function color monitor has Power mode and Economy mode (four levels).

Working Mode	Application	Advantage
P (P0,P1)	Power Mode	<ul style="list-style-type: none"> • Maximum production/power • Fast cycle time
E (E0,E1,E2,E3)	Economy Mode	<ul style="list-style-type: none"> • Good cycle time • Good fuel economy

Additionally, it is possible to select "Heavy lift mode" or "Swing priority mode" for each Power mode and Economy mode.

Selection	Display on the monitor
Heavy lift mode	
Swing priority mode	

Equipment Management Monitoring System

Monitor Function

Controller monitors engine oil level, coolant temperature, battery charge and air clogging, etc. If controller finds any abnormality, it is displayed on the LCD.



Maintenance Function

Monitor informs replacement time of oil and filters on LCD when the replacement interval is reached.

Trouble Data Memory Function

Monitor stores abnormalities for effective troubleshooting.



MAINTENANCE FEATURES

Easy Checking and Maintenance of Engine

Engine check points are concentrated on one side of the engine to facilitate daily checks. Thermal guards are placed around high-temperature parts such as turbocharger.



One-touch Drain Cock

Easier, cleaner engine oil changes.

Easy Cleaning of Cooling Unit

Reverse-rotation function of the hydraulic driven fan facilitates cleaning of the cooling unit. In addition, this function contributes to reducing warming-up run time in low temperature and discharging hot air from the engine room to keep appropriate heat balance.



Long-life Oil, Filter

Uses high-performance filtering materials and long-life oil. Extends the oil and filter replacement interval.



Hydraulic oil filter (Eco-white element)

Engine oil & Engine oil filter	every 500 hours
Hydraulic oil	every 5000 hours
Hydraulic oil filter	every 1000 hours

Wide Catwalk

Easier, safer operator cab access and maintenance checks.



Steps Connected to the Machine Cab

Steps allows access from left hand catwalk to top of machine for engine check and maintenance.



Convenient Utility Space

Utility space provides great convenience to store tools, spare parts, etc.



Washable Cab Floor Mat

Cab floor mat is easy to keep clean. The gently inclined surface has a flanged floor mat and drainage holes to facilitate runoff.



Electric Pump, Grease Gun with Indicator (optional)

Greasing is made easy with the electric pump, grease gun with indicator.

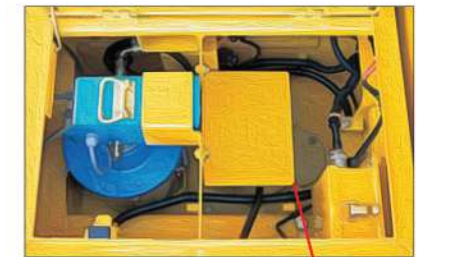

Grease can drum storage location



Grease gun The grease gun can be reached from ground level. Indicator

Divided Type Engine Cover

The divided engine cover allows easily access to inspection points around the engine.



Photo may include optional equipment.

SPECIFICATIONS

ENGINE

Model Komatsu SAA6D140E-5
 Type 4-cycle, water-cooled, direct injection
 Aspiration Turbocharged, aftercooled, cooled EGR
 Number of cylinders 6
 Bore 140 mm 5.51"
 Stroke 165 mm 6.50"
 Piston displacement 15.24 ltr 930 in³
 Governor All-speed, electronic
 Horsepower:
 SAE J1995 Gross 370 kW 496 HP
 ISO 9249 / SAE J1349* Net 363 kW 487 HP
 Rated rpm 1800 rpm
 Fan drive type Hydraulic

*Net horsepower at the maximum speed of radiator cooling fan is 338 kW 454HP. U.S. EPA Tier 3 and EU Stage 3A emissions certified.

HYDRAULIC SYSTEM

Type Open-center load-sensing system
 Number of selectable working modes 2

Main pump:
 Type Variable-capacity piston pumps
 Pumps for Boom, arm, bucket, swing, and travel circuits
 Maximum flow 2 x 494 ltr/min 2 x 130.5 U.S. gal/min

Fan drive pump Variable capacity piston type

Hydraulic motors:
 Travel 2 x axial piston motor with parking brake
 Swing 2 x axial piston motor with swing holding brake

Relief valve setting:
 Implement circuits 31.4 MPa 320 kg/cm² 4,550 psi
 Travel circuit 34.3 MPa 350 kg/cm² 4,980 psi
 Swing circuit 28.4 MPa 290 kg/cm² 4,120 psi
 Heavy lift circuit* 34.3 MPa 350 kg/cm² 4,980 psi
 Pilot circuit 2.9 MPa 30 kg/cm² 430 psi

*Backhoe only

Hydraulic cylinders:
 (Number of cylinders—bore x stroke x rod diameter)
 Boom 2 – 200 mm x 1950 mm x 140 mm 7.9" x 76.8" x 5.5"
 Arm 1 – 200 mm x 2250 mm x 140 mm 7.9" x 88.6" x 5.5"
 SE 2 – 185 mm x 1610 mm x 120 mm 7.3" x 63.4" x 4.7"
 Bucket
 Std. 1 – 185 mm x 1610 mm x 130 mm 7.3" x 63.4" x 5.1"
 SE 1 – 225 mm x 1420 mm x 160 mm 8.9" x 55.9" x 6.3"

SWING SYSTEM

Driven method Hydraulic motors
 Swing reduction Planetary gear
 Swing circle lubrication Grease-bathed
 Swing lock Oil disc brake
 Swing speed 6.8 rpm

DRIVES AND BRAKES

Steering control Two levers with pedals
 Drive method Fully hydrostatic
 Travel motor Axial piston motor, in-shoe design
 Reduction system Planetary gear triple reduction
 Maximum drawbar pull 559 kN 57000 kgf 125,660 lb
 Gradeability 70%
 Maximum travel speed
 Low 2.8 km/h 1.7 mph
 High 4.2 km/h 2.6 mph
 Service brake Hydraulic lock
 Parking brake Oil disc brake

UNDERCARRIAGE

Center frame H-leg frame
 Track frame Box-section
 Seal of track Sealed
 Track adjuster Hydraulic
 No. of shoes 47 each side
 No. of carrier rollers 3 each side
 No. of track rollers 8 each side

COOLANT AND LUBRICANT CAPACITY (REFILLING)

Fuel tank 980 ltr 258.9 U.S. gal
 Radiator 100 ltr 26.4 U.S. gal
 Engine 53 ltr 14.0 U.S. gal
 Final drive, each side 20 ltr 5.3 U.S. gal
 Swing drive 24.5 x 2 ltr 6.5 x 2 U.S. gal
 Hydraulic tank 470 ltr 124.2 U.S. gal

OPERATING WEIGHT (APPROXIMATE)

PC800-8E0: Operating weight, including 8200 mm 26'11" boom, 3600 mm 11'10" arm, SAE heaped 3.1 m³ 4.05 yd³ backhoe bucket, operator, lubricant, coolant, full fuel tank, and the standard equipment.

PC800-8E0 Super Earth mover (SE) spec.: Operating weight, including 7100 mm 23'4" boom, 2945 mm 9'8" arm, SAE heaped 4.0 m³ 5.23 yd³ backhoe bucket, operator, lubricant, coolant, full fuel tank, and the standard equipment.

Shoes	PC800-8E0		PC800-8E0 SE spec.	
	Operating Weight	Ground Pressure	Operating Weight	Ground Pressure
610 mm 24"	74500 kg 164,240 lb	122 kPa 1.24 kgf/cm ² 17.6 psi	75500 kg 166,450 lb	123 kPa 1.25 kgf/cm ² 17.8 psi
710 mm 28"	75300 kg 166,010 lb	106 kPa 1.08 kgf/cm ² 15.3 psi	76300 kg 168,210 lb	107 kPa 1.09 kgf/cm ² 15.5 psi
810 mm 32"	75830 kg 167,170 lb	93 kPa 0.95 kgf/cm ² 13.5 psi	76830 kg 169,380 lb	94 kPa 0.96 kgf/cm ² 13.7 psi
910 mm 36"	76470 kg 168,590 lb	83 kPa 0.85 kgf/cm ² 12.1 psi	77470 kg 170,790 lb	84 kPa 0.86 kgf/cm ² 12.2 psi
1010 mm 40"	77110 kg 170,000 lb	76 kPa 0.77 kgf/cm ² 11.0 psi	78110 kg 172,200 lb	76 kPa 0.78 kgf/cm ² 11.1 psi

BACKHOE DIMENSIONS

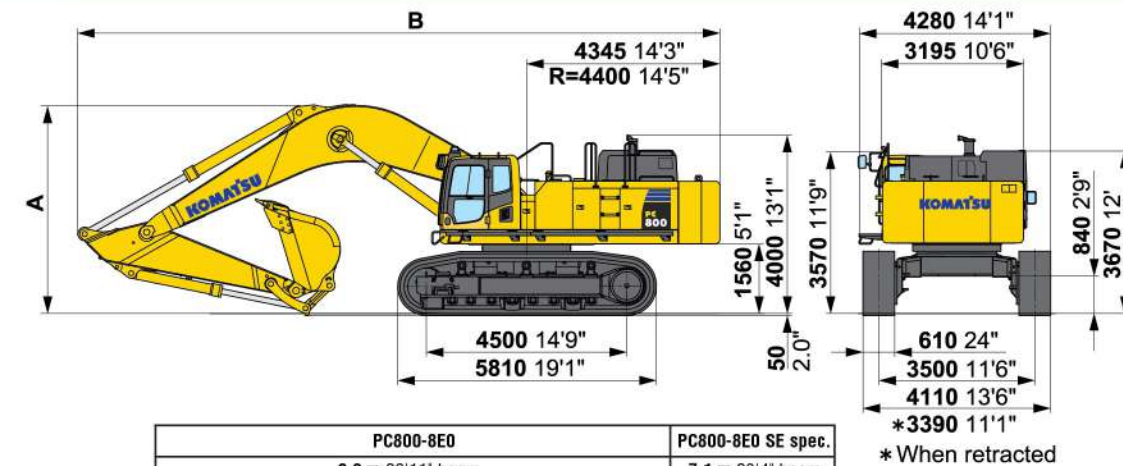

	PC800-8E0			PC800-8E0 SE spec.
	8.2 m 26'11" boom			7.1 m 23'4" boom
	3.6 m 11'10" arm	4.6 m 15'1" arm	5.6 m 18'4" arm	2.9 m 9'8" arm
A Overall Height	4690 mm 15'5"	5630 mm 18'6"	6260 mm 20'6"	4615 mm 15'2"
B Overall Length	14405 mm 47'3"	14435 mm 47'4"	14115 mm 46'4"	13130 mm 43'1"

WORKING RANGE

Unit: mm ft in

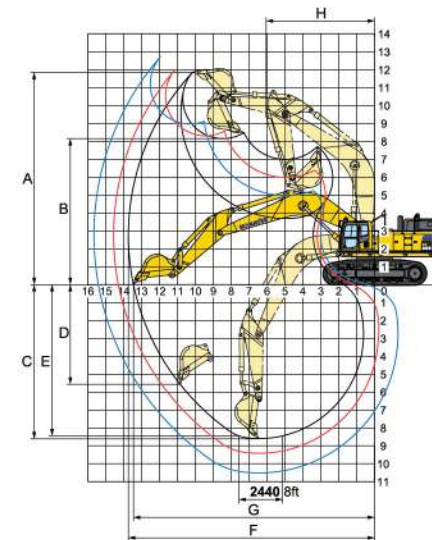

	PC800-8E0			PC800-8E0 SE spec.
	8200 mm 26'11"			7100 mm 23'4"
Boom length	8200 mm 26'11"			7100 mm 23'4"
Arm length	3600 mm 11'10"	4600 mm 15'1"	5600 mm 18'4"	2945 mm 9'8"
A Max. digging height	11840 mm 38'10"	12000 mm 39'4"	12690 mm 41'8"	11330 mm 37'2"
B Max. dumping height	8145 mm 26'7"	8295 mm 27'3"	8890 mm 29'2"	7525 mm 24'8"
C Max. digging depth	8600 mm 28'3"	9590 mm 31'6"	10595 mm 34'9"	7130 mm 23'5"
D Max. vertical wall digging depth	5575 mm 18'3"	6575 mm 21'7"	7920 mm 26'0"	4080 mm 13'5"
E Max. digging depth of cut for 8' level	8445 mm 27'8"	9455 mm 31'0"	10500 mm 34'5"	6980 mm 22'11"
F Max. digging reach	13740 mm 45'1"	14575 mm 47'1"	15635 mm 51'4"	12265 mm 40'3"
G Max. digging reach at ground level	13460 mm 44'2"	14310 mm 46'1"	15385 mm 50'6"	11945 mm 39'2"
H Min. swing radius	6060 mm 19'11"	6085 mm 20'0"	6145 mm 20'2"	5645 mm 18'6"
Bucket digging force (SAE J 1179) at power max.	324 kN 33000 kgf / 72,750 lb	324 kN 33000 kgf / 72,750 lb	324 kN 33000 kgf / 72,750 lb	428 kN 43600 kgf / 96,120 lb
Arm crowd force (SAE J 1179) at power max.	260 kN 26500 kgf / 58,420 lb	233 kN 23800 kgf / 52,470 lb	198 kN 20200 kgf / 44,530 lb	363 kN 37000 kgf / 81,570 lb
Bucket digging force (ISO 6015) at power max.	364 kN 37200 kgf / 82,010 lb	364 kN 37200 kgf / 82,010 lb	364 kN 37200 kgf / 82,010 lb	471 kN 48000 kgf / 105,820 lb
Arm crowd force (ISO 6015) at power max.	273 kN 27900 kgf / 61,510 lb	242 kN 24700 kgf / 54,450 lb	205 kN 20900 kgf / 46,080 lb	373 kN 38100 kgf / 84,000 lb

BACKHOE BUCKET, ARM, AND BOOM COMBINATION

BUCKET CAPACITY (HEAPED)				WIDTH		WEIGHT (with side cutters) kg lb	ARM LENGTH m ft in		
SAE J 296, PCSA m ³ yd ³	CECE m ³ yd ³	Without side shrouds, side cutters mm in	With side shrouds, side cutters mm in						
PC800-8E0 (use with 8.2 m 26'11" boom)							3.6 11'10"	4.6 15'1"	5.6 18'4"
2.8 3.66	2.5 3.27	1550 51.0'	1725 67.9'	2740 6,040	○	○	○		
3.1 4.05	2.8 3.66	1700 66.9'	1875 73.8'	2810 6,200	○	□	□		
3.4 4.45	3.0 3.92	1820 71.7'	1870 73.6'	3530 7,780	□	—	—		
PC800-8E0 SE spec. (use with 7.1 m 23'4" boom)							2.9 9'8"		
4.0 5.23	3.5 4.58	2000 78.7'	2100 82.8'	3730 8,230	○	○	○		
4.3 5.62	3.8 4.97	2150 84.6'	2250 88.6'	3940 8,690	○	□	□		
4.5 5.89	4.0 5.23	2230 87.8'	2330 91.7'	4030 8,890	□	□	□		

These charts are based on over-side stability with fully loaded bucket at maximum reach.
 ○ : General purpose use, density up to 1.8 t/m³ 3,000 lb/yd³ □ : General purpose use, density up to 1.5 t/m³ 2,500 lb/yd³
 — : Not useable

LOADING SHOVEL DIMENSIONS

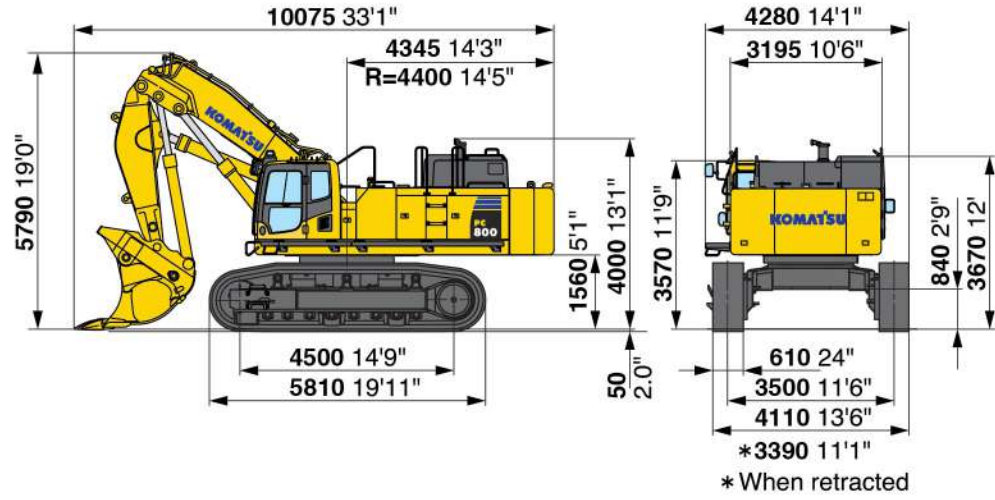

LOADING SHOVEL WORKING RANGE AND BUCKET SELECTION

Working Range

Type of bucket	Bottom dump			
	Capacity-heaped	4.5 m³	5.9 yd³	5.1 m³ 6.7 yd³
A	Max. cutting height	10800 mm		35'5"
B	Max. dumping height	7260 mm		23'10"
C	Max. digging depth	3605 mm		11'10"
D	Max. digging reach	10370 mm		34'0"
E	Max. digging reach at ground level	9990 mm		32'9"
F	Level crowding distance	3865 mm		12'8"
G	Min. crowd distance	5730 mm		18'10"
Bucket digging force		477 kN 48600 kgf 107,140 lb		
Arm crowd force		404 kN 41200 kgf 90,830 lb		

Bucket Selection

Type of bucket	Bottom dump			
	Capacity-heaped	4.5 m³	5.9 yd³	5.1 m³ 6.7 yd³
Width	2320 mm	91.3'	2620 mm	103.1'
Weight	6995 kg	15,420 lb	7665 kg	16,900 lb
No. of bucket teeth	6		6	
Recommended uses	General-purpose digging and loading		Light-duty excavation and loading	

LOADING SHOVEL OPERATING WEIGHT

Operating weight, including 4600 mm 15'1" boom, 3400 mm 11'2" arm, 4.5 m³ 5.9 yd³ heaped bucket, operator, lubricants, coolant, full fuel tank and standard equipment.

Shoes	Operating Weight	Ground Pressure
610 mm 24"	77300 kg 170,420 lb	126 kPa 1.28 kg/cm² 18.2 psi

LIFTING CAPACITY

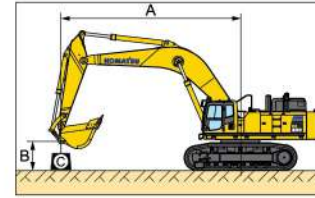

PC800-8E0

- Equipment:
- Boom: 8.2 m 26'11"
 - Arm: 3.6 m 11'10"
 - Bucket: 3.1 m³ 4.05 yd³
 - Shoe: 610 mm 24"
 - Counterweight: 9.8 ton 21,610 lb

- A: Reach from swing center
- B: Bucket hook height
- C: Lifting capacity
- Cf: Rating over front
- Cs: Rating over side
- C*: Rating at maximum reach

HEAVY LIFT "OFF"

Unit: kg lb

B	Maximum		9.0 m 29'		7.5 m 24'		6.0 m 19'		4.5 m 14'		3.0 m 9'	
	Cf	Cs	Cf	Cs	Cf	Cs	Cf	Cs	Cf	Cs	Cf	Cs
6.0 m 19'	*7750 *17,100	*7750 *17,100	*12250 *27,000	*12250 *27,000	*14050 *31,000	*14050 *31,000						
3.0 m 9'	*9050 *20,000	7150 15,800	*14600 *32,200	12100 26,700	*17950 *39,600	16300 35,900	*23900 *52,700	23000 50,700				
0 m 0'	9350 20,600	7050 15,500	14200 31,300	10850 23,900	19000 41,900	14450 31,900	*21700 *47,800	20400 45,000	*13550 *29,900	*13550 *29,900		
-3.0 m -9'	11050 24,400	8350 18,400	13800 30,400	10450 23,000	18500 40,800	13950 30,800	*22450 *49,500	20100 44,300	*20300 *44,800	*20300 *44,800	*19100 *42,100	*19100 *42,100
-6.0 m -19'	*13800 *30,400	13600 30,000			*14900 *32,800	14750 32,500	*19100 *42,100	*19100 *42,100	*22500 *49,600	*22500 *49,600		

HEAVY LIFT "ON"

Unit: kg lb

B	Maximum		9.0 m 29'		7.5 m 24'		6.0 m 19'		4.5 m 14'		3.0 m 9'	
	Cf	Cs	Cf	Cs	Cf	Cs	Cf	Cs	Cf	Cs	Cf	Cs
6.0 m 19'	*8800 *19,400	8400 18,500	*14000 *30,900	13700 30,200	*16000 *35,300	*16000 *35,300						
3.0 m 9'	9350 20,700	7150 15,700	15550 34,300	12100 26,700	*20500 *45,200	16300 36,000	*26900 *59,300	23000 50,800				
0 m 0'	9350 20,600	7050 15,500	14200 31,400	10850 23,900	19000 41,900	14450 31,900	*21700 *47,900	20400 45,000	*15100 *33,300	*15100 *33,300		
-3.0 m -9'	11050 24,300	8350 18,400	13800 30,400	10450 23,000	18500 40,800	13950 30,800	*22450 *49,500	20100 44,400	*20300 *44,700	*20300 *44,700	*21200 *46,700	*21200 *46,700
-6.0 m -19'	*16050 *35,400	13600 30,000			*17250 *38,100	14750 32,500	*22050 *48,600	21250 46,800	*22500 *49,600	*22500 *49,600		

* Load is limited by hydraulic capacity rather than tipping. Ratings are based on ISO 10567. Rated loads do not exceed 87% of hydraulic lift capacity or 75% of tipping load.

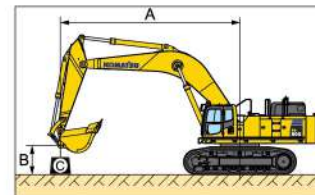

PC800-8E0

- Equipment:
- Boom: 8.2 m 26'11"
 - Arm: 4.6 m 15'1"
 - Bucket: 2.8 m³ 3.66 yd³
 - Shoe: 610 mm 24"
 - Counterweight: 9.8 ton 21,610 lb

- A: Reach from swing center
- B: Bucket hook height
- C: Lifting capacity
- Cf: Rating over front
- Cs: Rating over side
- C*: Rating at maximum reach

HEAVY LIFT "OFF"

Unit: kg lb

B	Maximum		12.0 m 39'		9.0 m 29'		7.5 m 24'		6.0 m 19'		4.5 m 14'		3.0 m 9'	
	Cf	Cs	Cf	Cs	Cf	Cs	Cf	Cs	Cf	Cs	Cf	Cs	Cf	Cs
6.0 m 19'	*6400 *14,100	*6400 *14,100	*7900 *17,400	7800 17,200	*10750 *23,700	*10750 *23,700								
3.0 m 9'	*7350 *16,200	6150 13,500	9400 20,700	7150 15,800	*13,400 *29,500	12450 27,500	*16350 *36,000	*16350 *36,000	*21400 *47,200	*21400 *47,200				
0 m 0'	8050 17,800	6000 13,200	8750 19,300	6550 14,400	14350 31,600	10950 24,100	19300 42,500	14700 32,400	*25950 *57,200	20800 45,900	*14600 *32,200	*14600 *32,200		
-3.0 m -9'	9200 20,300	6850 15,100			13600 30,000	10250 22,600	18300 40,300	13750 30,300	*26050 *57,400	19800 43,700	*23500 *51,800	*23500 *51,800	*15950 *35,100	*15,950 *35,100
-6.0 m -19'	*12650 *27,900	10050 22,200			*13300 *29,300	10500 23,200	*17100 *37,700	14050 31,000	*21850 *48,100	20400 45,000	*28600 *63,100	*28600 *63,100	*27150 *59,900	*27150 *59,900

HEAVY LIFT "ON"

Unit: kg lb

B	Maximum		12.0 m 39'		9.0 m 29'		7.5 m 24'		6.0 m 19'		4.5 m 14'		3.0 m 9'	
	Cf	Cs	Cf	Cs	Cf	Cs	Cf	Cs	Cf	Cs	Cf	Cs	Cf	Cs
6.0 m 19'	*7350 *16,200	7200 15,800	*9000 *19,800	7800 17,200	*12350 *27,300	*12350 *27,300								
3.0 m 9'	8150 18,000	6150 13,500	9400 20,700	7150 15,800	*15400 *34,000	12450 27,500	*18700 *41,200	17000 37,500	*24350 *53,700	*24350 *53,700				
0 m 0'	8050 17,800	6000 13,200	8750 19,300	6550 14,400	14350 31,600	10950 24,100	19300 42,500	14700 32,400	27800 61,300	20800 45,900	*16300 *36,000	*16300 *36,000		
-3.0 m -9'	9200 20,300	6850 15,100			13600 30,000	10250 22,600	18300 40,300	13750 30,300	26750 58,900	19800 43,700	*26000 *57,400	*26000 *57,400	*17750 *39,200	*17,750 *39,200
-6.0 m -19'	13300 29,300	10050 22,200			13900 30,600	10500 23,200	18650 41,100	14050 31,000	*25150 *55,400	20400 45,000	*30800 *67,900	*30800 *67,900	*27150 *59,900	*27,150 *59,900

* Load is limited by hydraulic capacity rather than tipping. Ratings are based on ISO 10567. Rated loads do not exceed 87% of hydraulic lift capacity or 75% of tipping load.



STANDARD EQUIPMENT

ENGINE AND RELATED ITEMS:

- Air cleaner, double element, dry
- Engine, Komatsu SAA6D140E-5
- Variable speed cooling fan, with fan guard

ELECTRICAL SYSTEM:

- Alternator, 60 amp, 24 V
- Auto decelerator and auto idling system
- Batteries, 170 Ah, 2 x 12 V
- Starting motors, 11kW
- Step light with timer
- Working lights-2 boom, 1 right front

UNDERCARRIAGE:

- 610 mm 24" double grouser
- Hydraulic track adjusters (each side)
- Sealed track
- 8 track/3 carrier rollers (each side)
- Variable track gauge

GUARDS AND COVERS:

- Dust-proof net for radiator and oil cooler
- Pump/engine room partition cover
- Travel motor guards

OPERATOR ENVIRONMENT:

- Cab with pull-up type front window
- Damper mount, all-weather, sound-suppressed cab with tinted safety glass windows, lockable door, intermittent window wiper and washer, floormat, cigarette lighter and ashtray
- Multi-function color monitor, electronically-controlled throttle dials, electric service meter, gauges (coolant temperature, hydraulic oil temperature and fuel level), caution lights (electric charge, engine oil pressure, and air cleaner clogging), indicator lights (engine preheating and swing lock light) level check lights (coolant, engine oil, and hydraulic oil level), self-diagnostic system with trouble data memory
- Rear view mirror (RH and LH)
- Seat, fully adjustable with suspension

HYDRAULIC CONTROLS:

- Control levers and pedals for steering and travel with PPC system
- Control levers, wrist control levers for arm, boom, bucket, and swing with PPC system
- Fully hydraulic, with Electronic Open-center Load Sensing System and engine speed sensing (pump and engine mutual control system)
- Heavy lift mode system
- In-line filter
- Oil cooler
- One axial piston motor per track for travel with counter balance valve
- Power max function
- Shockless boom control
- Swing priority mode system
- Two axial piston motors for swing with single-stage relief valve
- Two control valves, 5+4 spools (boom, arm, bucket, swing, and travel)
- Two-mode setting for boom
- Two variable capacity piston pumps

DRIVE AND BRAKE SYSTEM:

- Brakes, hydraulic lock travel brakes, oil disc parking
- Hydrostatic two travel speed system with planetary triple reduction final drive

OTHER STANDARD EQUIPMENT:

- Automatic swing holding brake
- Catwalk
- Counterweight, 9800 kg 21,610 lb
- Horn, electric
- Large handrails
- Marks and plates, English
- One-touch engine oil drainage
- Paint, Komatsu standard
- Preventive Maintenance (PM) tune-up service connector
- Rear reflector
- Slip-resistant plates
- Travel alarm



OPTIONAL EQUIPMENT

- Additional track guard
- Air suspension seat
- Alternator, 90 amp, 24 V
- Arms (Backhoe):
PC800-8E0:
— 3600 mm 11'10" arm assembly
— 4600 mm 15'1" arm assembly
— 5600 mm 18'4" arm assembly
PC800-8E0 SE spec.:
— 2945 mm 9'8" SE arm assembly
- Auto air conditioner
- Booms (Backhoe):
PC800-8E0:
— 8200 mm 26'11" boom assembly
PC800-8E0 SE spec.:
— 7100 mm 23'4" SE boom assembly
- Cab front guard level 2 (ISO 10262)

- Cab with fixed front window
- Coolant heater
- Counterweight 11850 kg 26,120 lb
- Double flange track roller
- 12V electric supply
- Fire extinguisher
- Full length track guard
- General tool kit
- Electric pump, grease gun with indicator
- High cab mount
- Interconnected horn and warning light
- Large-capacity batteries
- Loading shovel attachments
- Lower wiper
- OPG top guard level 2 (ISO 10262)
- Provision for fast fuel fill
- Radio AM/FM

- Rain visor
- Rear view monitoring system
- Seat belt 78 mm 3", 50 mm 2"
- Shoes:
— 710 mm 28" double grouser
— 810 mm 32" double grouser
— 910 mm 36" double grouser
— 1010 mm 40" double grouser
- Spare parts for first service
- Strengthened revolving frame underguard
- Sun visor
- Track frame undercover (center)
- Vandalism protection locks
- Working lights 2 (on cab)

M E M O

www.komatsu.com

Printed in Japan 201509 IP.As

KOMATSU[®]



金駿機械
GUM CHUN MACHINERY



陳列倉 Show Room: 香港新界石崗粉錦公路DD111 LOT2373&2374 (近橫台山永寧里)
DD111 LOT2373&2374 Fan Kam Road, Shek Kong, Yuen Long, N.T., Hong Kong
通訊地址 Mailing Address: P.O. Box No. 729 at Shek Wu Hui Post Office

☎ (852) 2488-9393

🏠 (852) 2488-9337

🌐 www.gumchun.com.hk

CEN00383-02

Materials and specifications are subject to change without notice.
KOMATSU[®] is a trademark of Komatsu Ltd. Japan.